



Index	Pos.	Ident No.	Description	
<b>DT 4.4</b>	3	948029 00000	SEALING RING A 14x18x2	
	4	951228 02000	LOCKING SCREW G 1/4"	
	5	948034 00000	SEALING RING A 17x21x1,5	
	6	951228 00000	LOCKING SCREW G 3/8"	
	21	903247 00000	GASKET	
	22	903248 00000	GASKET	
	23	000100 27100	PUMP-BODY	
	24	945307 00000	SOCKET HEAD SCREW	
	25	020000 27100	ROTOR	
	26	960600 03000	FILLING PIECE	
	27	901387 00000	<b>CARBON VANES (5x)*</b>	
	29	909580 00000	<b>FILTER CARTRIDGE (1x)</b>	
	30	000700 27100	LID	
	31	945312 00000	SOCKET HEAD SCREW	
101	943138 00000	NOZZLE		
104	728000 99687	PRESSURE REGULATING VALVE		

<b>DT 4.8</b>	3	948034 00000	SEALING RING A 17x21x1,5	
	4	951228 00000	LOCKING SCREW G 3/8"	
	21	903250 00000	GASKET	
	22	903249 00000	GASKET	
	23	000100 27200	PUMP-BODY	
	24	945308 00000	SOCKET HEAD SCREW	
	25	020000 27200	ROTOR	
	26	960600 09000	FILLING PIECE	
	27	901388 00000	<b>CARBON VANES (5x)*</b>	
	29	909581 00000	<b>FILTER CARTRIDGE (1x)</b>	
	30	000700 27200	LID	
	31	945314 00000	SOCKET HEAD SCREW	
	101	943139 00000	SILENCING NOZZLE	
	104	728000 99687	PRESSURE REGULATING VALVE	

Index	Pos.	Ident No.	Description	
<b>VT 4.4</b>	3	948029 00000	SEALING RING A 14x18x2	
	4	951228 02000	LOCKING SCREW G 1/4"	
	5	948034 00000	SEALING RING A 17x21x1,5	
	6	951228 00000	LOCKING SCREW G 3/8"	
	21	903247 00000	GASKET	
	22	903248 00000	GASKET	
	23	000100 27100	PUMP-BODY	
	24	945307 00000	SOCKET HEAD SCREW	
	25	020000 27100	ROTOR	
	26	960600 03000	FILLING PIECE	
	27	901387 00000	<b>CARBON VANES (5x)*</b>	
	29	909580 00000	<b>FILTER CARTRIDGE (1x)</b>	
	30	000700 27100	LID	
	31	945312 00000	SOCKET HEAD SCREW	
102	736000 99688	VACUUM REGULATING VALVE		
103	727500 99689	BLOW-OFF VALVE		

<b>VT 4.8</b>	3	948034 00000	SEALING RING A 17x21x1,5	
	4	951228 00000	LOCKING SCREW G 3/8"	
	21	903250 00000	GASKET	
	22	903249 00000	GASKET	
	23	000100 27200	PUMP-BODY	
	24	945308 00000	SOCKET HEAD SCREW	
	25	020000 27200	ROTOR	
	26	960600 09000	FILLING PIECE	
	27	901388 00000	<b>CARBON VANES (5x)*</b>	
	29	909581 00000	<b>FILTER CARTRIDGE (1x)</b>	
	30	000700 27200	LID	
	31	945314 00000	SOCKET HEAD SCREW	
	102	736000 99688	VACUUM REGULATING VALVE	
	103	727500 99689	BLOW-OFF VALVE	

\* necessary order quantity / maintenance

Drawing - see appendix 

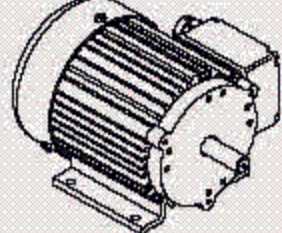

**SERVICE** ? 

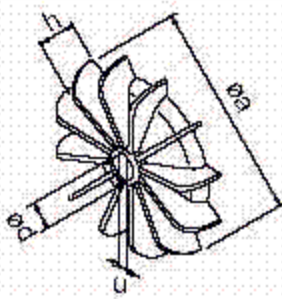
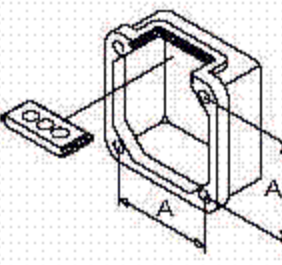
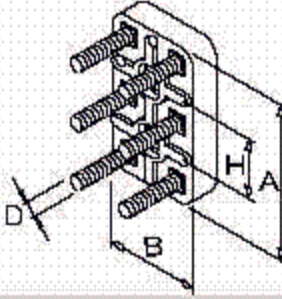
1~

C = ?  $\mu$ F  
U = ? V

Druck  
Pressure  
Pressione  
Presión

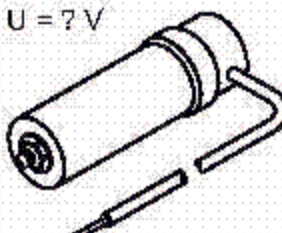
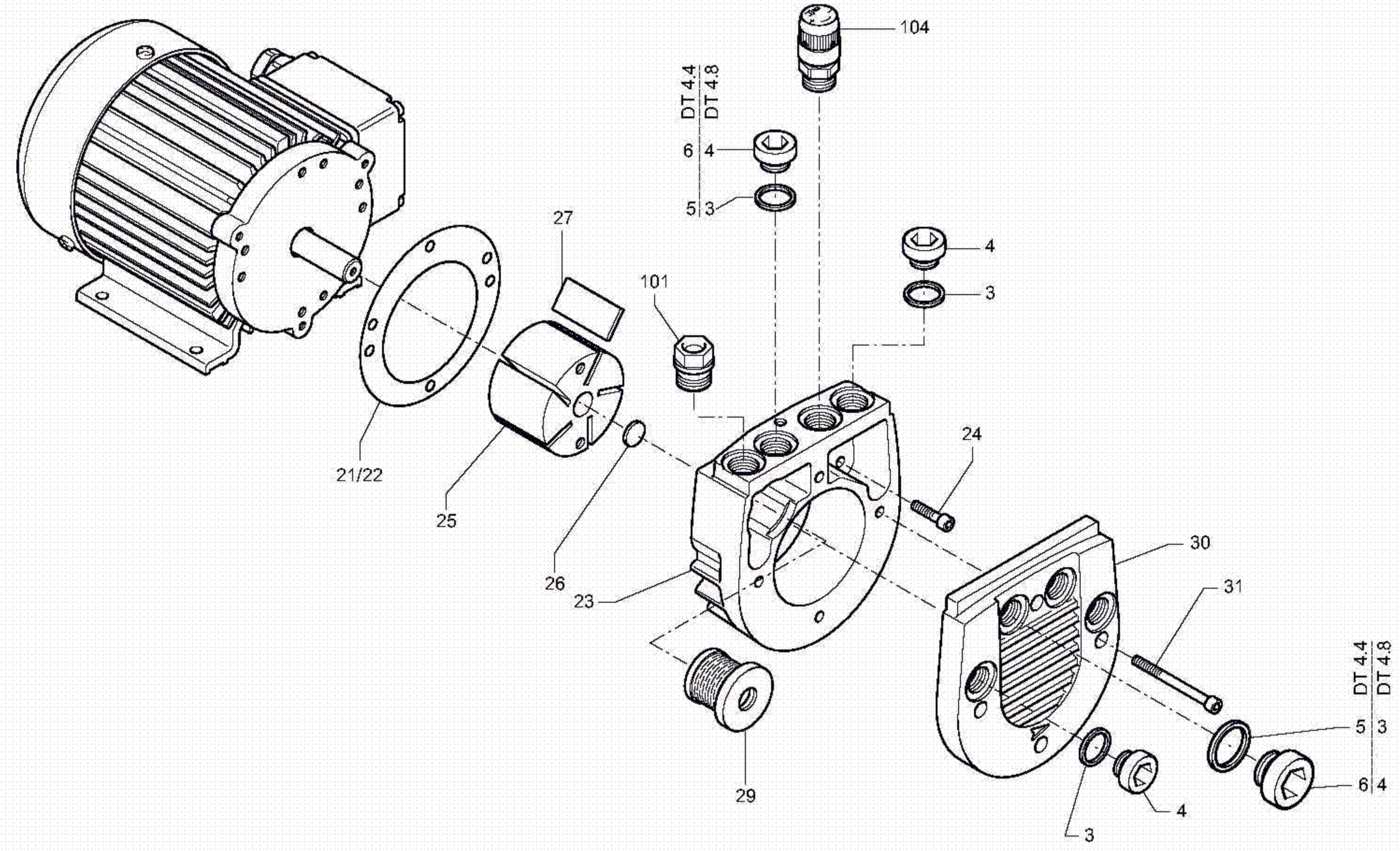
DT 4.4  
DT 4.8

Vakuum  
Vacuum  
Vide  
Vuoto  
Vacío