

Index	Pos.	Ident No.	Description
	□	549000 22500	GASKET SET ¹⁾
	1	000100 22500	PUMP BODY
	5	020000 22500	ROTOR
	7	901373 01000	ROTOR VANES (10x) ²⁾
	9	947814 00000	KEY
	10	000700 22500	LID
	11	000800 22500	LID
	12	001100 22500	BEARING COVER
	13	001000 22500	BEARING COVER
	14	001101 22500	BEARING COVER
	15	945322 00000	SOCKET HEAD SCREW
	16	945319 00000	SOCKET HEAD SCREW
	17	945230 00000	HEX-HEAD SCREW
	18	948743 00000	GROOVED PIN
	21	068900 22500	GREASE DISTRIBUTION WASHER
	22	945270 00000	SHAFT END BOLD
	23	968001 60000	DISTANCE DISC
	24	906614 00000	BEARING
	25	906636 00000	BALL BEARING
	26	913112 50100	O-RING
	27	911450 00000	DISTANCE DISC 45X55X0,025
	28	911451 00000	DISTANCE DISC 45X55X0,05
	29	911413 60000	DISTANCE DISC 65X85X0,025
	30	911413 70000	DISTANCE DISC 65X85X0,05
	31	917162 00000	COMPENSATING DISC
	32	948265 00000	LOCKING RING
	34	906580 00000	SHAFT SEALING RING
	35	911326 00000	SEAL
	37	008100 22200	CONDUIT-GREASE
	38	949001 00000	GREASE NIPPLE
	40	003100 22500	GASKET
	41	520800 22500	PROTECTIVE HOOD
	47	009600 10100	DOMPENER
	48	945333 00000	SOCKET HEAD SCREW
	50	068000 22500	SPACING COLLAR
	54	015100 22500	FOOT
	57	945382 00000	SOCKET HEAD SCREW
	58	948804 00000	RING SCREW
	61	560200 22500	CONNECTION FLANGE
	67	945361 00000	SOCKET HEAD SCREW
	68	947507 00000	WASHER
	70	544500 22500	COUPLING WITH FAN
	81	040101 22500	FILTER HOUSING
	85	007800 22500	CONNECTION FLANGE
	88	945336 00000	SOCKET HEAD SCREW
	89	007900 22500	GASKET
	92	945362 00000	SOCKET HEAD SCREW
	94	003000 22500	GASKET
	95	040201 22500	FILTER COVER
	96	945338 00000	SOCKET HEAD SCREW



DTLF / VTLF 400-500

Index	Pos.	Ident No.	Description
	97	950308 00000	WASHER
	102	040100 22500	FILTER HOUSING
	106	945330 00000	SOCKET HEAD SCREW
	107	005600 22500	COVER
	110	945373 00000	SOCKET HEAD SCREW
	118	909540 00000	FILTER CARTRIDGE C18133 (1x) ²⁾
	119	008900 22500	GASKET
	120	040200 22500	FILTER COVER
	123	009000 27000	LEAF SPRING
	164	002100 22500	COUPLING MOTOR SIDE, Ø48MM
	164	002101 22500	COUPLING MOTOR SIDE, Ø55MM
	164	002102 22500	COUPLING MOTOR SIDE, Ø60MM
	170	946114 00000	THREADED PIN
	173	902230 00000	COUPLING DISC
	187	500900 22500	MOTOR FLANGE, B5/350
	187	500901 22500	MOTOR FLANGE, B5/400
	187	500902 22500	MOTOR FLANGE, B5/450
	201	947109 00000	HEX. NUT
	203	946962 00000	STUD
	204	947509 00000	WASHER
	221	741341 00000	RUBBER BUFFER
	222	946961 00000	STUD
	223	945241 00000	HEX. HEAD SCREW
	421	533700 99620	PRESSURE RELIEVE VALVE, 1-1.7BAR
	421	533702 99620	BLOW-OFF VALVE, 0.15BAR
	421	533703 99620	PRESSURE RELIEVE VALVE, <1BAR
	425	533701 99620	VACUUM RELIEF VALVE
	442	007400 22500	SILENCER HOUSING
	444	945384 00000	SOCKET HEAD SCREW, M8X190
	448	945346 00000	SOCKET HEAD SCREW, M8X140
	451	007601 16900	SIEVE-TUBE
	452	907700 90000	SILENCER SPONGE
	453	007501 16600	GASKET
	454	007800 16600	CONNECTING FLANGE
	455	945320 00000	SOCKET HEAD SCREW



DTLF / VTLF 400-500

¹⁾ Set of seals - 54900022500 - Pos.: 38, 89, 94, 119, 120, 130

²⁾ necessary order quantity / maintenance

OPTIONAL

VTLF 400	SK	Special design – extra cooling
VTLF 500	SK	“ “ “ “

Items different from standard appliance see appendix (back of drawing)

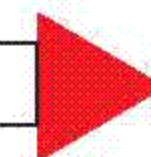

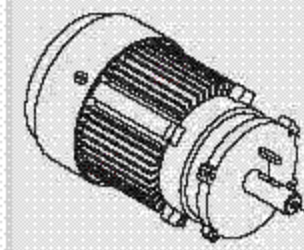

SERVICE ?

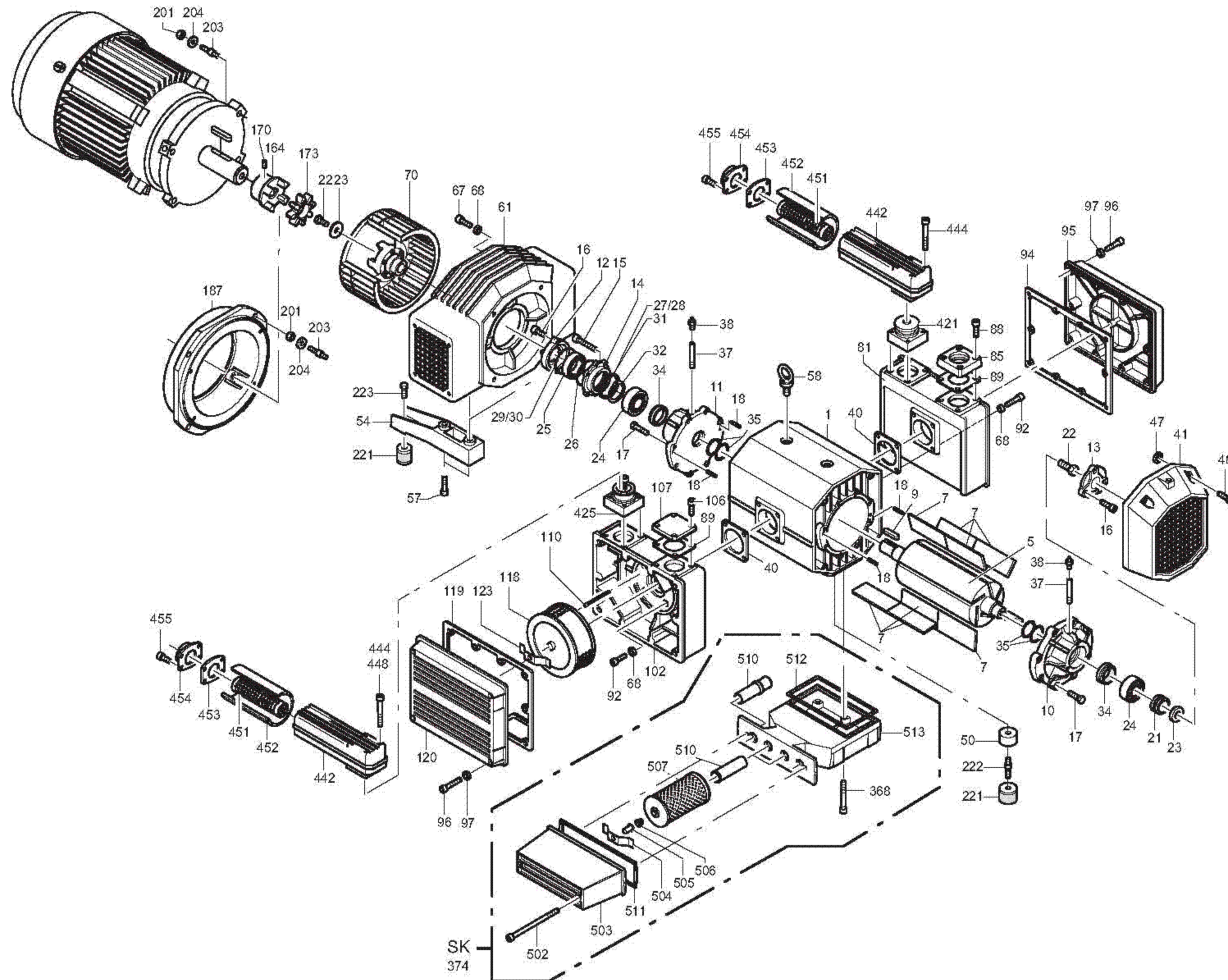
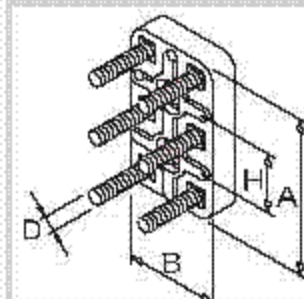
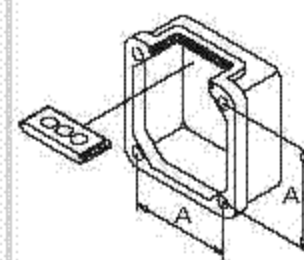
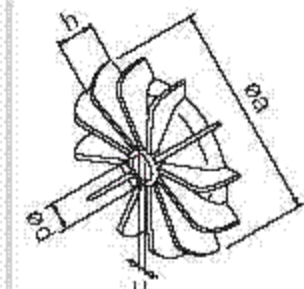
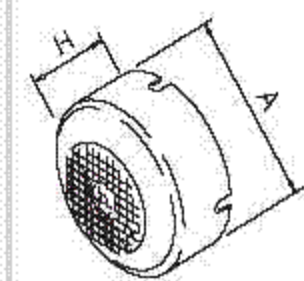

standard

DTLF 400
DTLF 500

VTLF 400
VTLF 500

optional
en option
opcionale
opcional

