



U 4.250

Pos.	Ident No.	Description
□	549000 26400	GASKET SET ¹⁾
1	000100 26500	PUMP BODY
3	020000 26500	ROTOR
5	900507 00000	ROTOR VANE IN PLASTIC (3x) ²⁾
7	917611 00000	BEARING SEALING WASHER
8	911472 00000	DISTANCE DISC
9	906662 00000	BEARING 6207 DIN 625
10	906574 00000	SHAFT SEALING RING
11	912821 00000	CAP
15	000800 26500	LID WITH FLANGE
16	000700 26500	LID
17	912871 00000	LOCKING SCREW
18	902108 00000	COUPLING
19	902210 00000	COUPLING DISC
21	945331 00000	SOCKET HEAD SCREW
22	948742 00000	STRAIGHT PIN
24	947733 00000	KEY
28	952008 00000	LOCATING PEG
30	502301 26400	FAN
31	947732 00000	KEY
32	945270 00000	SHAFT END BOLD
33	949409 00000	WASHER
39	053200 26500	CONNECTION FLANGE
40	945320 00000	SOCKET HEAD SCREW
41	537501 26400	NON RETURN VALVE, ENTIRE
46	008002 26400	SIEVE
47	945371 00000	SOCKET HEAD SCREW
49	951602 00000	RING UNIT
50	946969 00000	STUD
52	951228 02000	LOCKING SCREW
61	002403 26400	HOUSING FOR OIL SEPARATION
62	951221 00000	LOCKING SCREW
64	001702 26400	OIL TANK COVER
67	003701 26400	COVER
69	946968 00000	STUD
70	948507 00000	SPRING WASHER
71	947105 00000	HEX.NUT
74	305800 02000	COUPLING NUT
76	727501 99628	BLOW OFF VALVE
83	965415 00000	OIL SEPARATION ELEMENT (2x) ²⁾
89	921500 50000	HANDLE
90	013300 26400	METAL FILTER
91	945318 00000	SOCKET HEAD SCREW
93	945226 00000	HEX. HEAD SCREW
94	867800 99559	FLOAT
95	003300 10700	NOZZLE
97	912300 00000	CONNECTING SCREW
101	506000 26400	COARSE SEPARATOR
104	008001 26400	SIEVE
112	003703 26400	COVER
119	907309 00000	OIL SIGHT GLASS
120	916800 10000	COVER
124	947104 00000	HEX.NUT
125	948504 00000	SPRING WASHER
126	951001 02000	STUD
128	951003 02000	STUD
130	945383 00000	SOCKET HEAD SCREW
131	945330 00000	SOCKET HEAD SCREW



U 4.250

Pos.	Ident No.	Description
132	945363 00000	SOCKET HEAD SCREW
133	945321 00000	SOCKET HEAD SCREW
134	945324 00000	SOCKET HEAD SCREW
135	951220 00000	LOCKING SCREW
141	012206 26400	PIPE
143	012202 26400	OIL RETURN PIPE
144	012201 26500	PIPE
148	948402 00000	HOLLOW SCREW
151	012203 26400	OIL SUCTION PIPE
152	009400 19000	HOLLOW HOLDING SCREW
154	012900 19000	LOCKING SCREW
156	912306 00000	CONNECTING SCREW
157	960201 26400	COOLER
159	012205 26400	PIPE
181	018301 26400	PROTECTING HOOD
184	945127 00000	HEX-HEAD SCREW
185	947506 00000	WASHER
186	947106 00000	NUT
187	568100 26400	SUPPORT PILLAR
188	949408 00000	WASHER
190	001800 20000	SCREW
193	949203 00000	TOOTHED SPRING WASHER
197	741302 00000	RUBBER BUFFER
198	945634 00000	THREADED PIN
218	902100 21900	COUPLING MOTOR SIDE Ø38mm
233	537500 10700	VALVE, ENTIRE
282	741103 99682	OIL LEVEL CONTROL - OPTIONAL
313	902100 21300	COUPLING MOTOR SIDE (US)
314	945238 00000	HEX-HEAD SCREW (US)
316	037900 10400	INTERMEDIATE FLANGE (US)



¹⁾ Set of seals - 54900026400
 - Pos.: 13, 25, 26, 37, 38, 44, 53, 63, 77, 79, 80, 118, 121, 129, 136, 149, 153
²⁾ necessary order quantity / maintenance

OPTIONAL

- U 4.250 SA/K -51 Special design – with oil bath heating, level transmitter and heat valve
- 54 Special design – with additional oil draining bore hole
- U 4.250 F/K -51 Special design – with oil bath heating, level transmitter and heat valve

Items different from standard appliance see appendix (back of drawing)

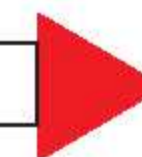

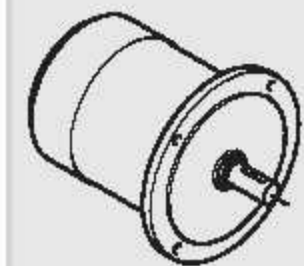

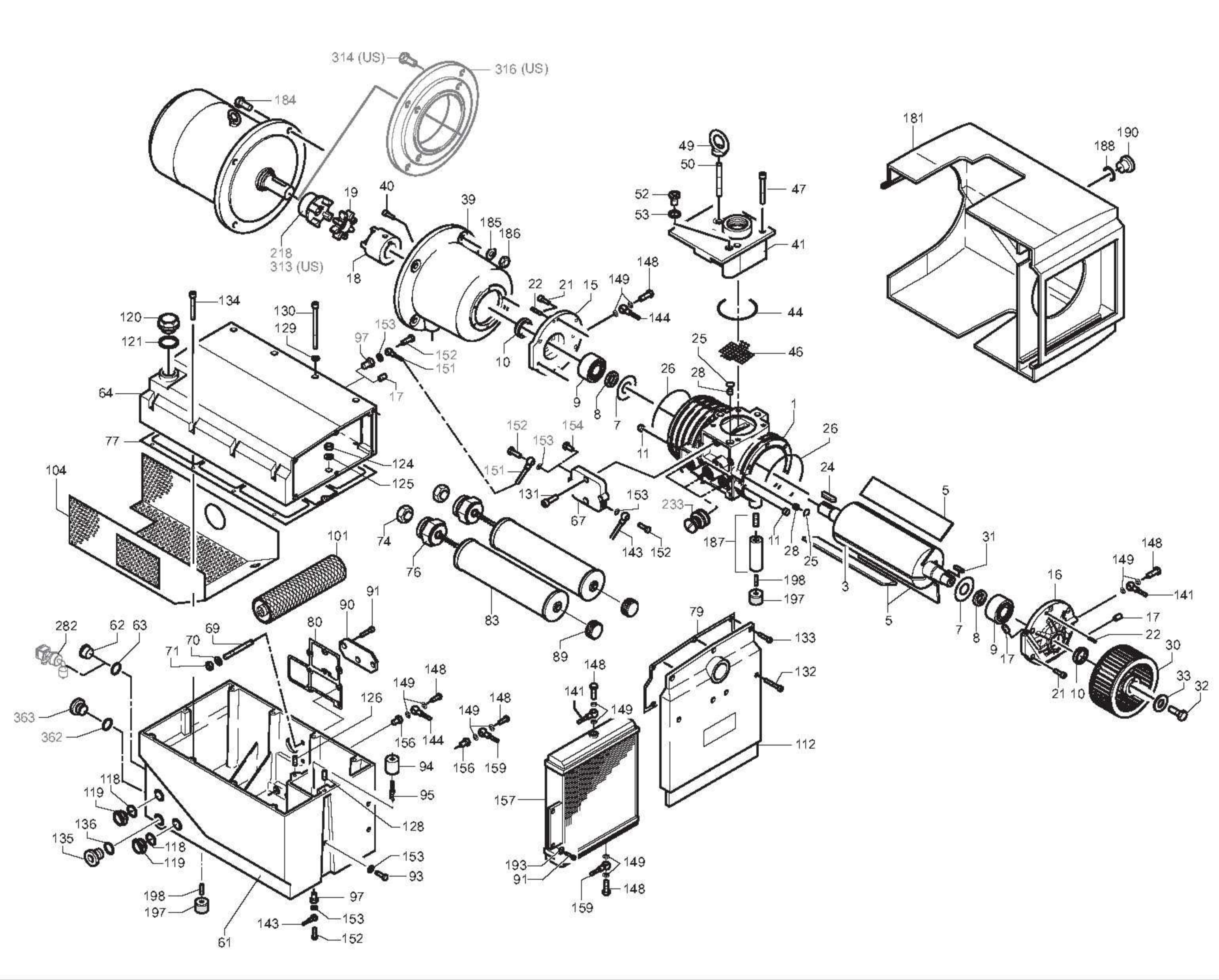
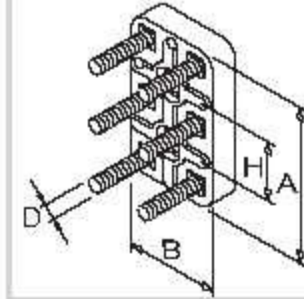
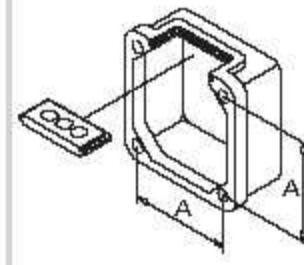
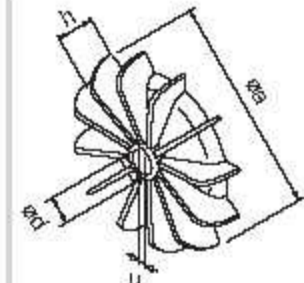
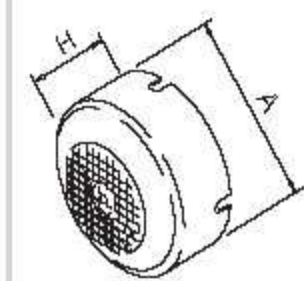

SERVICE ?



standard

U 4.250 F/K
U 4.250 SA/K

optional
en option
opcionale
opcional

optional en option optionale opcional	Variante(n) Modifications Variantes	Pos			Bestell Nr. Ident No. No. Identification No. Identificazione No. De pedido	Beschreibung / Description / Designation / Designazione / Descripcion
U 4.250 SA/XX U 4.250 F/XX	U 4.250 SA/K - 51 U 4.250 F/K - 51	61 62 282 340 341 342 343	X X X X X	X X	741103 99682 002404 26400 960202 26400 943400 70000 948029 00000	NIVEAUGEBER / LEVEL TRANSMITTER / CAPTEUR DE NIVEAU / INDICATORE DI LIVELLO / CODIFICADOR DE NIVEL ÖLABSCHEIDERGEHÄUSE / HOUSING FOR OIL SEPARATION / CARCASSE POUR SEPARATION D'HUILLE / CARCASSA SEPARATORE OLIO / CARCASA SEPARADORA DE ACEITE ROHRHEIZKÖRPER / PIPE HEATER / CORPS DE CHAUFFE / SCALDIGLIA / CALEFACTOR TUBULAR TEMPERATUR-WÄCHTER / THERMOSTAT / THERMOSTAT / INTERRUTTORE TERMICO / TERMOSTATO DICHRING / SEALING RING / JOINT / ANELLO / ANILLO
	U 4.250 SA/K - 54	61 361 362 363	X X X X	X	002405 26400 948013 00000 951220 00000	ÖLABSCHEIDERGEHÄUSE / HOUSING FOR OIL SEPARATION / CARCASSE POUR SEPARATION D'HUILLE / CARCASSA SEPARATORE OLIO / CARCASA SEPARADORA DE ACEITE DICHRING / SEALING RING / JOINT / ANELLO / ANILLO VERSCHLUSSSCHRAUBE / LOCKING SCREW / BOUCHON / VITE DI CHIUSURA / TORNILLO DE CIERRE

 standard